

# The Kalamino Cistern

## Roof Water Harvesting System

### CONSTRUCTION & IMPLEMENTATION GUIDELINE

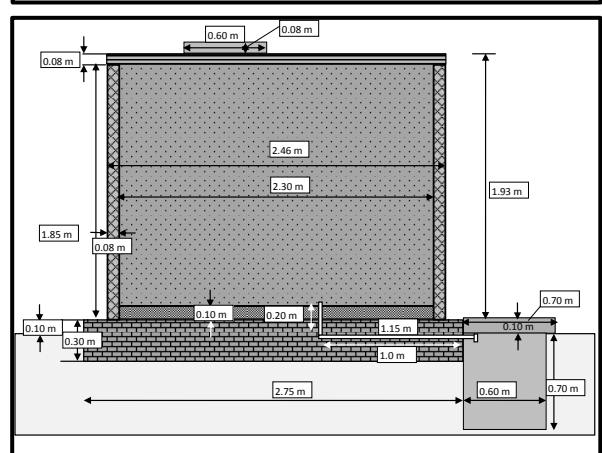

HELVETAS Swiss Intercooperation Ethiopia;  
 Chris Annen, Asmelash Kidanemariam  
 Addis Ababa, April 2016



Tigray National Regional State  
 Bureau of Water Resource  
 Development

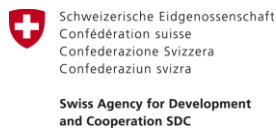

Technology development and design:  
HELVETAS Swiss Intercooperation, Ethiopia,  
Chris Annen, Asmelash Kidanemariam

Photographs: HELVETAS Swiss Intercooperation; Chris Annen, Asmelash Kidanemariam, Christian Bobst

Contact:  
HELVETAS Swiss Intercooperation, Ethiopia; PoB 27507/1000 Addis Ababa  
Tel: +251(0)114672934/5/6; Fax: +251(0)114672949  
Website: [https://www.helvetas.org/projects\\_\\_\\_countries/countries/ethiopia.cfm](https://www.helvetas.org/projects___countries/countries/ethiopia.cfm)

<b>Table of contents</b>	
Introduction	2
1. Description of major components	3
2. Selecting a community for roof water harvesting (RWH)	3
3. Selecting beneficiary households	4
4. Selecting houses suitable for RWH	4
5. Kalamino cistern design	5
6. Constructing the cistern foundation	7
7. Cistern molds	8
7.1 Cistern body mold	8
7.2 Cistern manhole mold	9
7.3 Cistern cover mold	9
7.4 Cistern cover mold support bars	9
8. Cistern body construction	11
9. Cistern cover construction	14
10. Outlet pit construction	18
11. Connecting the roof catchment	19
12. First splash discharge outlet	18
13. Operation and maintenance	18
13.1 Cleaning the cistern	18
13.2 Chlorination	18
Appendix	19
I. Quality management	19
II. Common mistakes	20
III. Bill of quantity (BoQ) - Construction materials	21
IV. Bill of quantity (BoQ) – Construction materials for cistern molds	23

<b>Acronyms</b>
<b>ETB</b>
Ethiopian Birr: 1 USD = ETB 21
<b>GSP</b>
<i>Galvanized steel pipe</i>
<b>HH</b>
<i>Household</i>
<b>ISP</b>
<i>Iron steel pipe</i>
<b>Lt</b>
Liter
<b>PPC</b>
<i>Portland Pozzolana Cement</i>
<b>RHS</b>
Rectangular hollow steel
<b>RWH</b>
Roof water harvesting
<b>RWHS</b>
Roof water harvesting system
<b>WASHCO</b>
Water sanitation and hygiene committee

### ***Strategic points of consideration***

- In communities with severe water supply constraints, RWH can reduce women's workload by more than 3 hours per day or 100 working days per year.
- With an operational lifespan of 20 years for a Kalamino Cistern RWH system, the cost per m<sup>3</sup> of water is about ETB 55 (USD 2.6) as compared to ETB 3-6 per m<sup>3</sup> from public water supply.
- A Kalamino Cistern RWH system can deliver 7'200 or 9'000 Lt per year if operated at 130% capacity (by filling-using-refilling during the rainy season), which represents 20-25 Lt of drinking water per day year-round.
- In communities with extreme water supply constraints, the cost of fetching 20 Lt water can be ETB 12 (USD 0.6) or more.
- The cost of supplying 7'200 Lt in such communities would be ETB 4,320 (USD 206); hence the investment cost recovery period is 2 years.
- Locally recruited Community Technicians (CT) need 14 days of practical training. A pair of CT equipped with 1 set of molds can construct 4 RWH systems per month.
- HHs should be organized in WASHCOs for sustainable management of the RWH systems.
- Linking RWH development to profitable economic activities for HH and communal asset building is essential for sustaining the investment and/or expanding HH based RWH systems on demand and at cost. This can create new business opportunities for unemployed youth.

### **Introduction**

Roof water harvesting (RWH) is a reliable alternative source of household drinking water in locations where surface- and groundwater are either unavailable, out of reach, or unsafe. It is particularly suitable for communities and households (HHs) with severe drinking water constraints. Such communities are often located on mountain tops, along ridges, or in dry plains with deep water tables that are too costly to explore. Under such circumstances, RWH can improve the living conditions of women, female children and entire communities significantly.

Over the past five years, the Tigray-based Beles SUNRise Project (BSP) of HELVETAS Swiss Intercooperation, Ethiopia, has developed and successfully disseminated the most cost effective HH-based RWH system currently available in Ethiopia. The cistern (including foundation and roof connection pipes and fittings) costs only 35% of the price of a conventional PVC tank of the same storage volume. This guideline explains in detail how the Kalamino Cistern Roof Water Harvesting System is constructed. Prior to embarking on a RWH scheme, its advantages and disadvantages require careful consideration:

#### **Advantages**

- Water is delivered to the homestead where it is most needed.
- RWH can supply water in communities where there are no alternative sources of drinking water.
- RWH is suitable for highly scattered settlements where the implementation of a communal water supply is difficult or too costly.
- RWH can supply safe drinking water where alternative surface- or groundwater sources are contaminated.
- Water harvested from roofs is owned and managed by individual HHs.
- The promotion of RWH systems can provide new business opportunities in rural communities and urban centers.

#### **Disadvantages**

- HH-based RWH is more costly than communal water supply.
- Subsidizing the technology is required for poor HHs.
- Water quality monitoring and periodic purification is required.
- First splash discharge outlets need to be operated properly in order to secure safe water supply from roofs.
- Roofs can harvest only very limited amounts of water which can primarily serve HH drinking water needs.
- The installation and maintenance of RWH systems requires proper skills training of local Community Technicians.

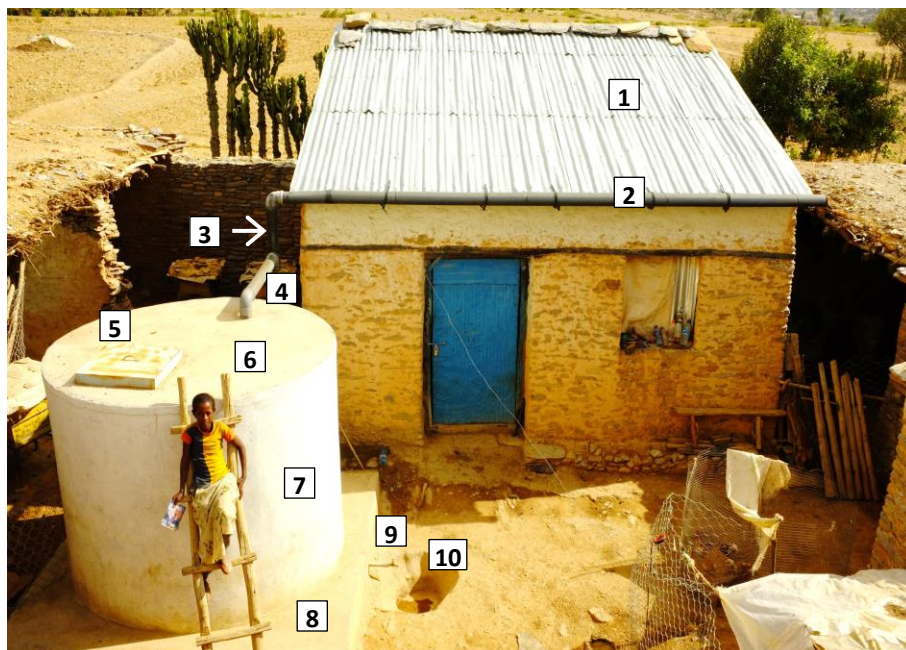

Picture 1: The Kalamino Cistern Roof Water Harvesting System

## 1. Description of major components

1. Corrugated iron sheet roof
2. PVC rainwater collection pipe
3. First splash discharge outlet
4. Rainwater cistern inlet
5. Manhole with cover
6. Cistern cover
7. Cistern body
8. Foundation
9. Water tap
10. Outlet pit

## 2. Selecting a community for roof water harvesting (RWH)

When selecting a community, households and houses for RWH, the following criteria must be considered:

- 1) Are other less costly options for improving drinking water supply such as spring development, shallow wells or rock water harvesting available?
- 2) Is scarcity of safe drinking water perceived as a major problem by the community; and do they attach clear priority to improving their drinking water supply?
- 3) Are community leaders willing to include the project in the community's annual development plan?
- 4) Are community representatives and beneficiary HHs willing and ready to:
  - a) Accept selection criteria and procedures for identifying beneficiary HHs which have been mutually agreed upon;
  - b) mobilize necessary free community labor;
  - c) supply the required, locally available materials;
  - d) provide adequate storage for construction material during construction;
  - e) organize adequate water supply for cement curing<sup>1</sup> during construction;
  - f) organize beneficiary HHs in WASHCOs;
  - g) actively engage in planning, implementation, monitoring and evaluation of the project;
  - h) collect appropriate water fees to ensure water quality monitoring and proper maintenance of the RWH scheme.

1: Curing - for explanation see Appendix II

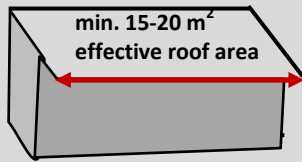

a) Level roof: Cistern can be positioned on either side

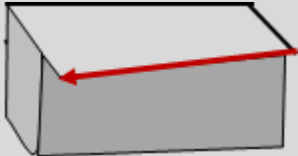

b) Graded roof: Cistern must be positioned to the lower end

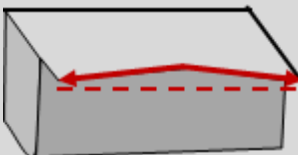

c) Roof graded towards two sides: Not suitable for RWH unless corrected to grading towards one side. Alternatively, an open, hanging gutter can be fitted below (dotted line).

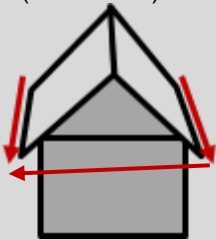

d) 2 sides of a tipped roof can be used for water harvesting into one cistern if roof edges are level or graded to the same direction. Alternatively, an open, hanging gutter can be fitted.

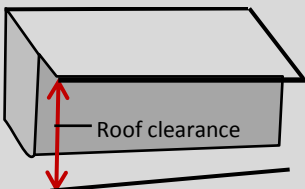

e) Roof ground clearance is the space between the ground and the roof

Figure 1: Roof gradients & ground clearance

5) Are there sufficient HHs with severe drinking water supply constraints to warrant introducing RWH?

A set of molds costs USD 1,122 (ETB 21,350). Hence, a minimum of 100 cisterns should be constructed per mold.

### 3. Selecting beneficiary households

- 1) Does the HH fulfill predetermined social selection criteria?
- 2) Does the HH head agree to
  - a) participate in all necessary training;
  - b) agree to utilize water from the RWH cistern primarily for drinking purposes;
  - c) provide adequate family manpower for construction (if feasible);
  - d) ensure proper utilization of materials;
  - e) pay an adequate fee in order to ensure maintenance (spare parts) and water safety (chlorination);
  - f) cooperate with instructions of the WASHCO and apply improved hygiene and sanitation standards?

### 4. Selecting houses suitable for RWH

- 1) Is there enough effective roof area for RWH?
 

The prerequisite minimum effective roof area is 15-20 m<sup>2</sup>. This is based on the assumption that the average annual rainfall is 600 mm, of which 80% will be collected.

1 mm rainfall = 1Lt rainwater per m<sup>2</sup> x 80% = 0.8 Lt/m<sup>2</sup>

15 m<sup>2</sup> x 600 mm x 0.8 = 7'200 Lt (The storage capacity of the Kalamino Cistern is 7'200 Lt).

Note: Only the roof area that can be connected to the PVC collection pipe is to be considered.
- 2) Does the corrugated iron sheet roof have the quality required for RWH?
 

Dirty or contaminated roofs (that cannot be cleaned) or old, perforated iron sheets with only a short lifespan remaining should not be considered for RWH.
- 3) Can the roof be drained towards one side?
 

Flat roofs (a) or roofs with a gradient towards one side (b) are most suitable. Uneven roofs or roofs with gradients towards two sides are not suitable unless such gradient is corrected (c).
- 4) Is the clearance between ground level and the roof (e) sufficient to install the cistern?
 

The clearance (e) must be a minimum of 2.5m where the cistern foundation is above ground, and 2.2 m where it is underground.

## 5. Kalamino cistern design

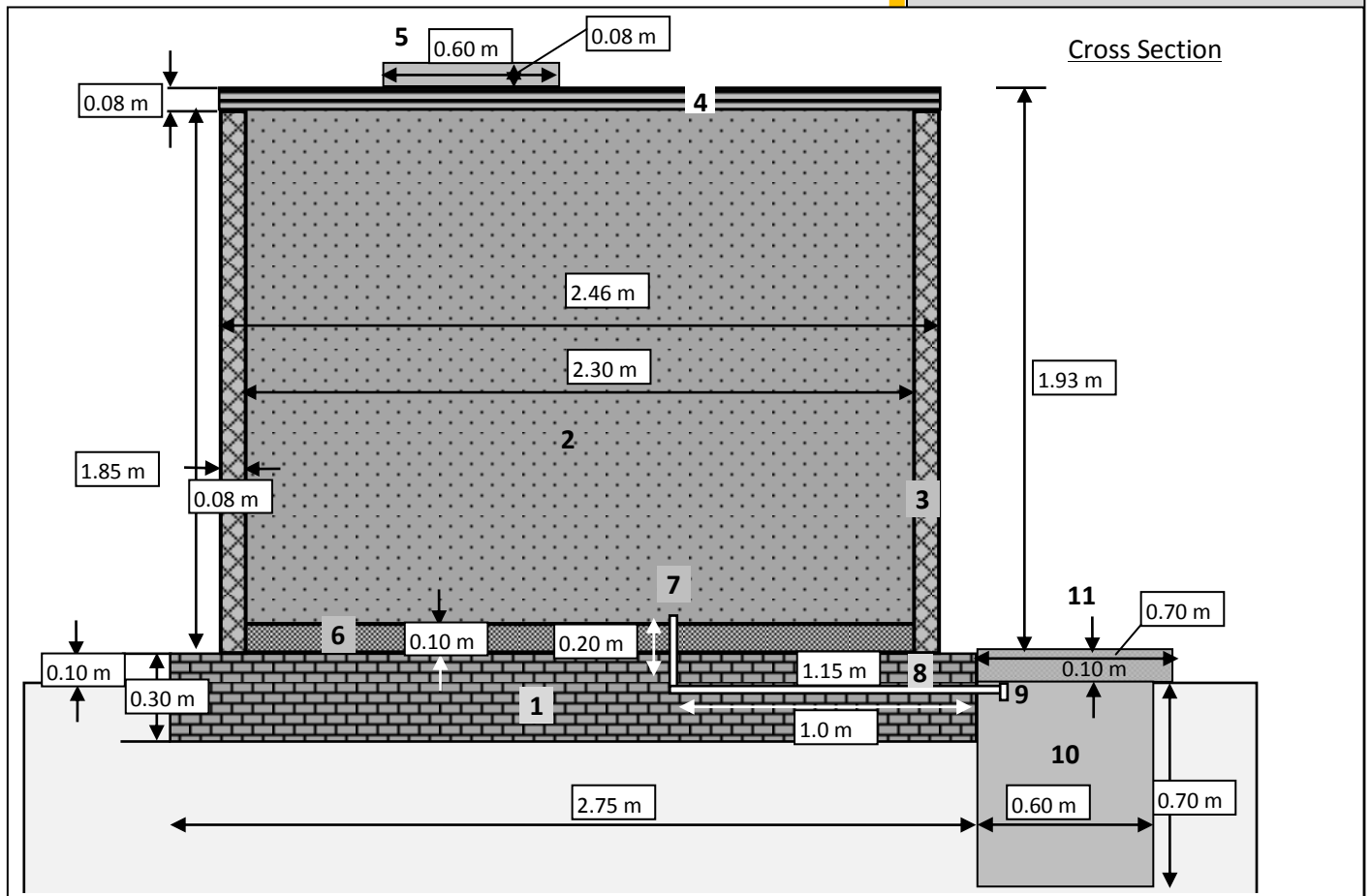

Figure 2: The Kalamino Cistern: Crosse section

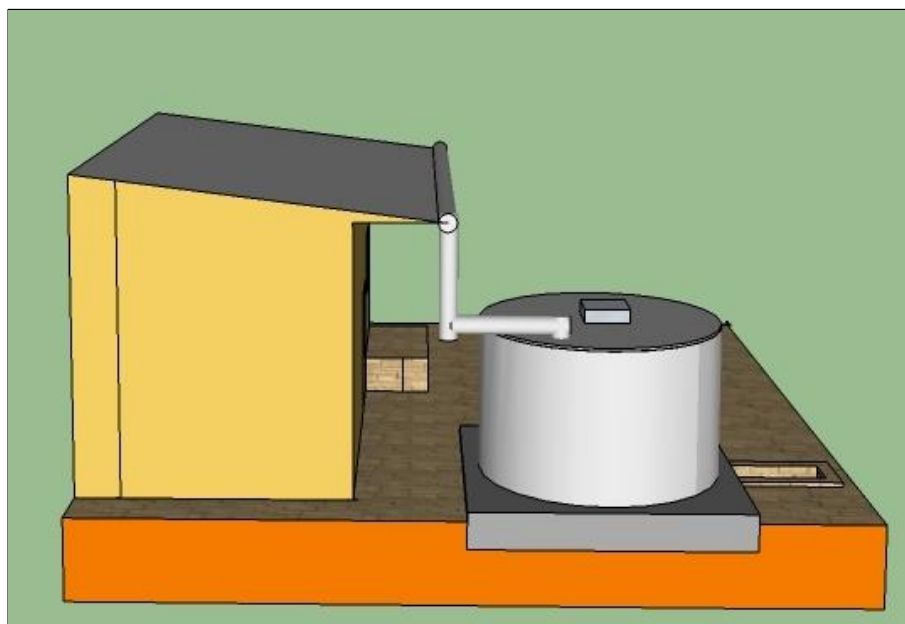

Figure 3: The Kalamino cistern schematic side view

### Legend

1. Cistern foundation
2. Cistern body
3. Cistern wall
4. Cistern cover
5. Cistern cover lid
6. Cistern floor (concrete slab)
7. Outlet pipe (vertical)
8. Outlet pipe (horizontal)
9. Water tap
10. Outlet pit
11. Pit rim

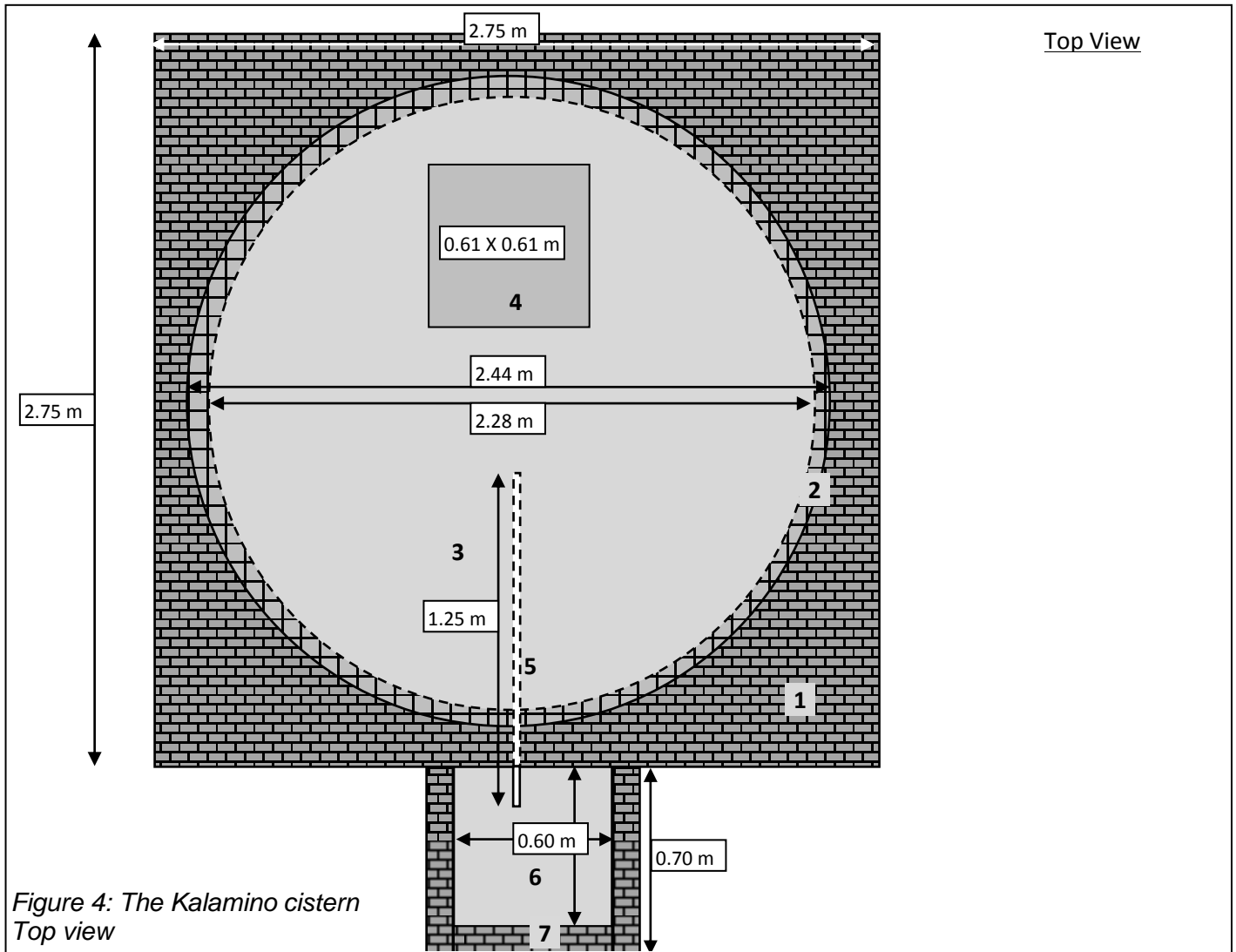

Figure 4: The Kalamino cistern  
Top view

Legend

1. Cistern foundation
2. Cistern wall
3. Cistern cover
4. Cistern cover lid
5. Outlet pipe
6. Outlet pit
7. Outlet pit rim

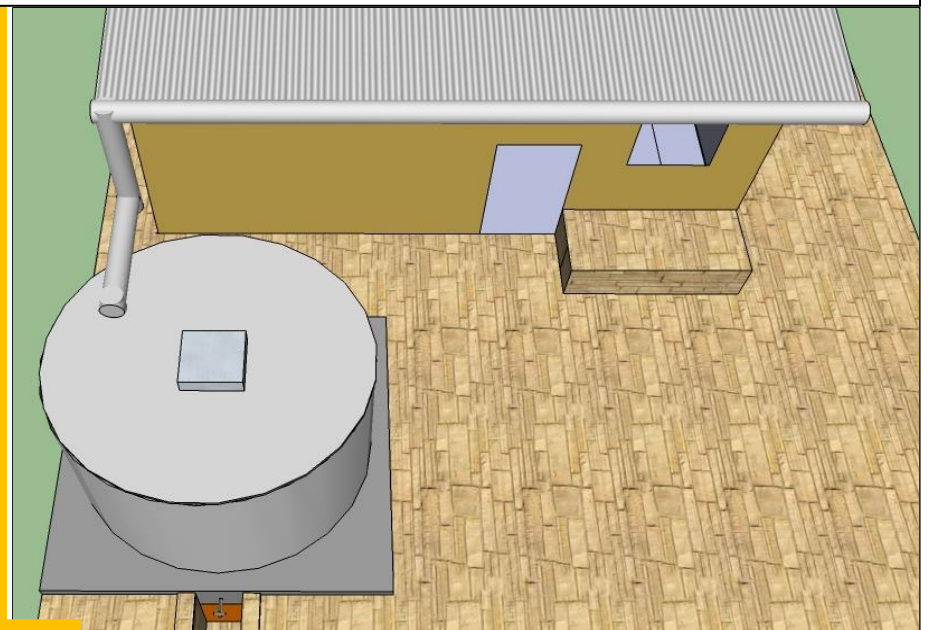

Figure 5: The Kalamino cistern - Schematic top view



### Working steps

Select the suitable site for the cistern based on the roof gradient (if any). Mark the dimension of the foundation on the compound with the beneficiary.

There are several options for constructing the foundation:

- If you have rocky underground and sufficient roof clearance, build only a small 20 cm thick masonry cement foundation.
- If the roof clearance is less than 2.5 m, construct an underground masonry cement foundation.
- If the roof clearance is 2.5 m or more, construct a 30 cm thick masonry cement foundation above ground. Compact the ground before constructing.

In all cases, place the outlet pipe at the center of the cistern 15 cm below the foundation surface, with the vertical outlet pipe not less than 15 cm above the surface of the foundation.

Note: The horizontal outlet pipe must be perfectly level.

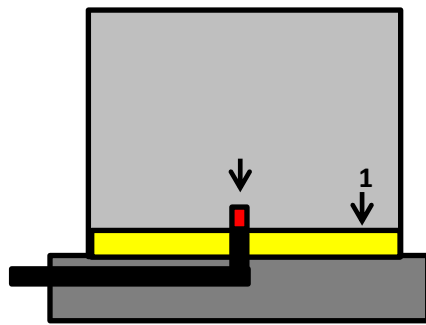

Figure 6: Additional 10 cm concrete floor (marked yellow) will be cast (1) inside the cistern once the cistern body is in place (see Picture 18). A 5 cm section of outlet pipe (marked red) can be detached for flushing out cleaning water.

Figure 6: Features of cistern foundation and concrete floor



Picture 4: Placing the outlet pipe inside the foundation

## 6. Constructing the cistern foundation



Picture 2: Outlet pipe



Picture 3: Outlet pipe

Picture 3: The section marked in red sticks out of the cistern floor (see Figure 6) so that sediment particles are not flushed out through the tap. It can be screwed off for cleaning the cistern i.e. to flush out cleaning water through the outlet pipe.



*Pictures 5&6: Kalamino cistern body mold; 1/4 circle sections*  
 Pictures 5 & 6: The PVC pipes are fixed permanently onto the steel frame of the four body mold circular sections. This makes the mold lighter and easier to handle. The horizontal lining of the PVC pipes provides an ideal cement profile (after inside cement plastering and removal of the mold) for outside cement plastering (see Picture 17).

## 7. Cistern molds

### 7.1 Cistern body mold

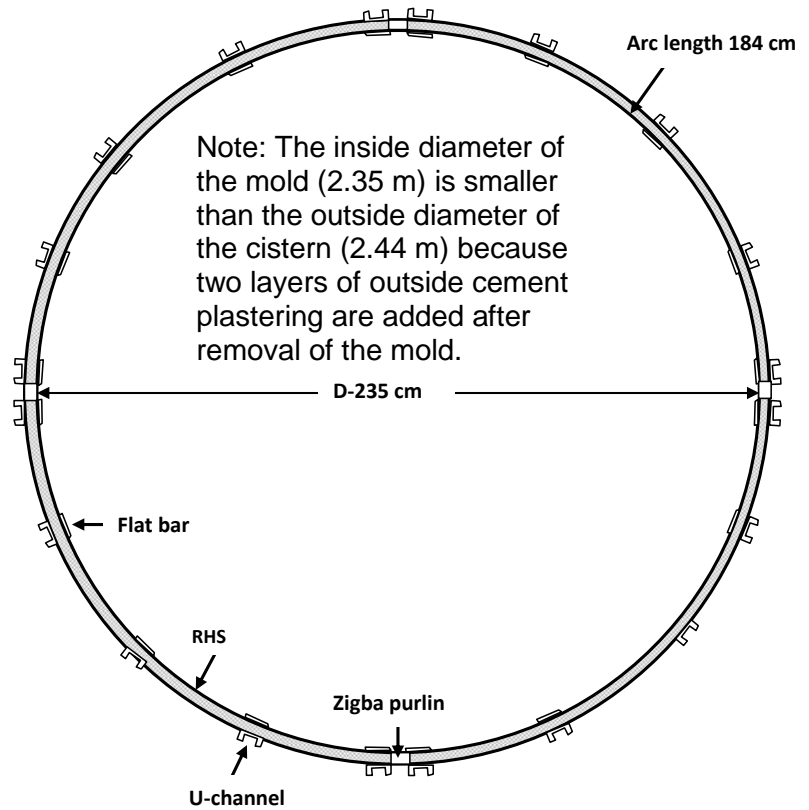

*Figure 6: Kalamino cistern body mold; Top view*

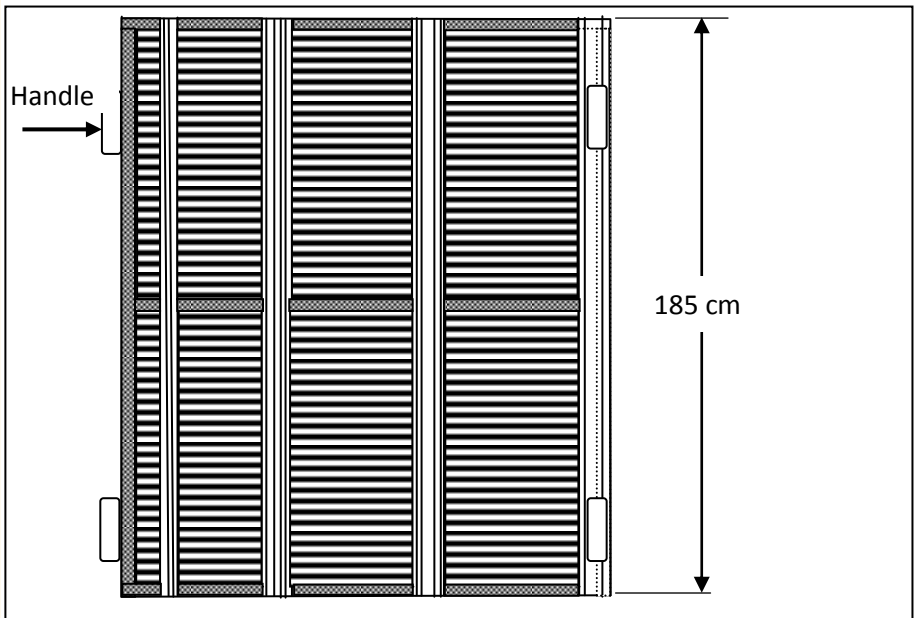

*Figure 7: Kalamino cistern body mold; 1/4 circle section – Side view*

### 7.3 Cistern cover mold

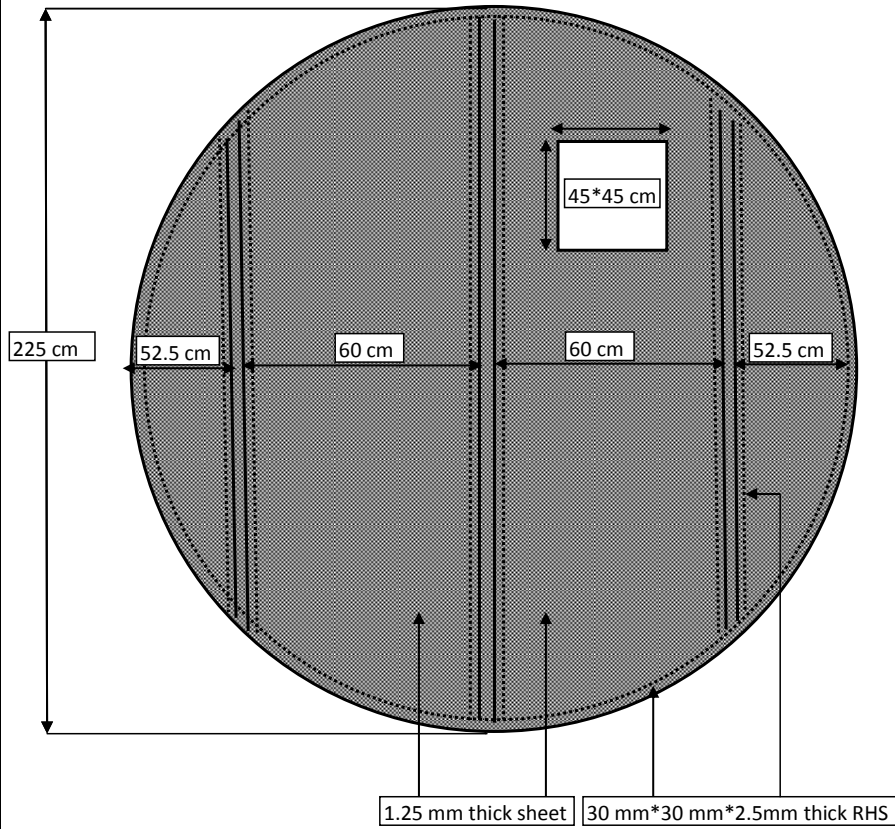

Figure 8: Kalamino cistern cover mold – Top view

### 7.4 Cistern cover mold support bars

RHS = rectangular hollow steel

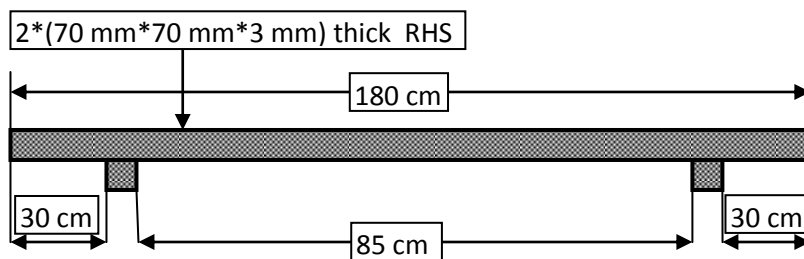

Figure 9: Kalamino cistern cover mold support – Side view

### 7.2 Manhole molds

The manhole molds consist of a box of 2 mm metal sheet (45 x 45 x 20 cm) and two rectangular pieces (50 x 50 cm x 8 cm) used to cast the manhole rim.



Picture 7: Manhole mold box



Picture 8: Manhole mold rectangles



Picture 9: Manhole mold assembled

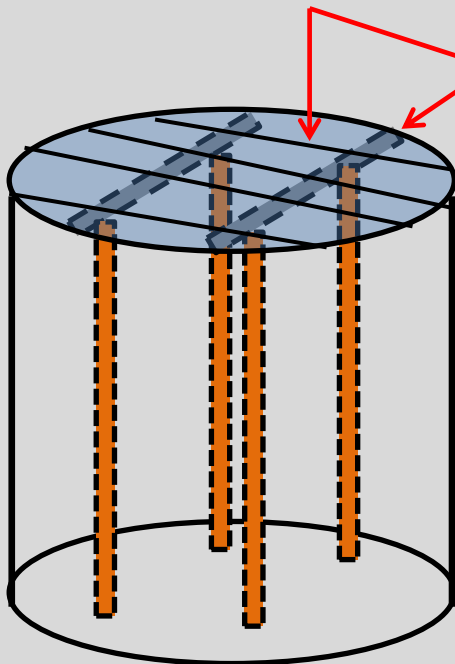

Figure 10: Mounting the cistern cover mold on horizontal support bars and vertical wooden support stilts



Picture 10: Kalamino cistern cover mold – Top view



Picture 11: Kalamino cistern cover mold – seen from below

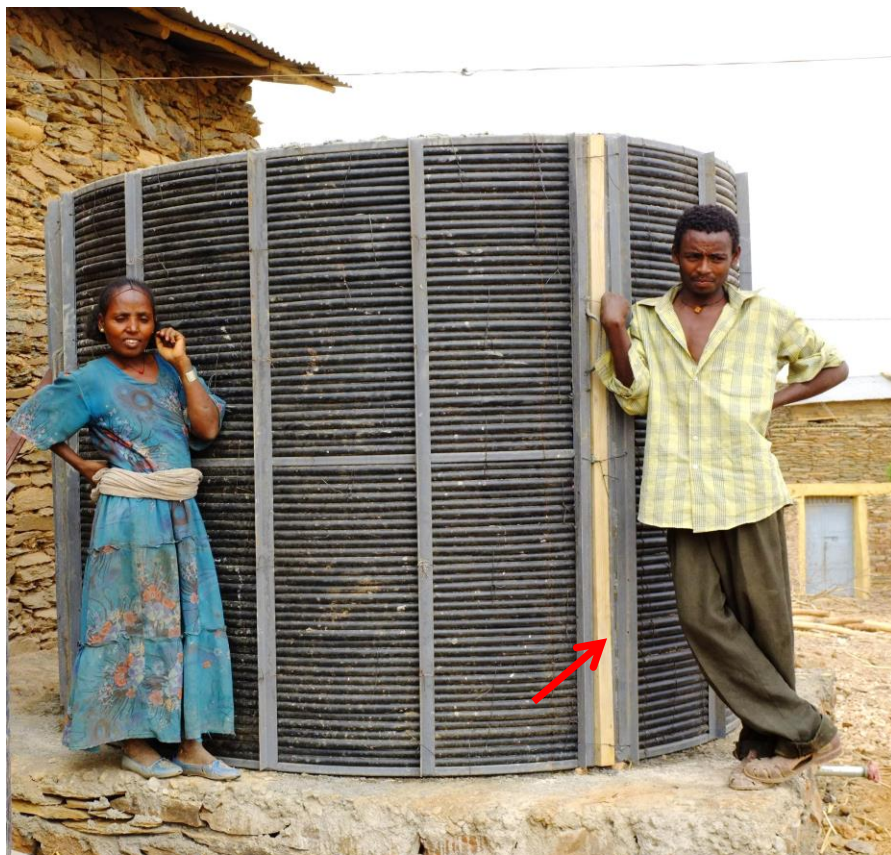

Picture 12: Assembled cistern body mold consisting of four quarter circle sections: Note the wooden spacers placed between mold sections.



Picture 13: A pick-up load of wire mesh ready for transport

## 8. Cistern body construction

### Working steps

- Mark the center of the foundation
- Use a 1.15 m rope pegged at the center, and clearly mark the position of the cistern boundary in a circle on the foundation.
- Arrange the four mold parts and align them on the marked circle. Place wooden spacers between the mold sections.
- When aligned, tie the mold sections together with wire.
- Open a role of the wire mesh and stretch it on the ground.
- Bend it to the reverse side so that it can be laid flat on the ground.

Picture 13: Galvanized wire mesh rolls of 1.85 m x 7.50 m are used to give stability to the cistern body. 2.3 mm thick wires are used, framed with one line of 5 mm thick wire.

This method allows for the construction of a strong cistern body with only a 7-8 cm thick ferrocement wall. No reinforcement bars are used for constructing the cistern body.

**Working steps (continued)**

- g) Line the wire mesh along the inside of the body mold.
- h) Tie the wire mesh with black wire (2 mm) to the mold in such a way that the black wire can be cut from the outside when removing the mold after plastering the inside.
- i) Apply two layers of cement plastering to the inside of the mold in two days.
- j) Cure cement for 4 days.



Picture 14: 1<sup>st</sup> round cement plastering after lining the wire mesh



Picture 15: Lining of the wire mesh along the inside of the body mold.



Picture 16: Assembled cistern body mold with one layer cement plastering inside



Picture 17: Profile of cistern body after removing the mold



Picture 18: Casting of 10 cm cistern floor after cistern body construction

**Working steps (continued)**

k) Remove outside mold and clean away cement residues.

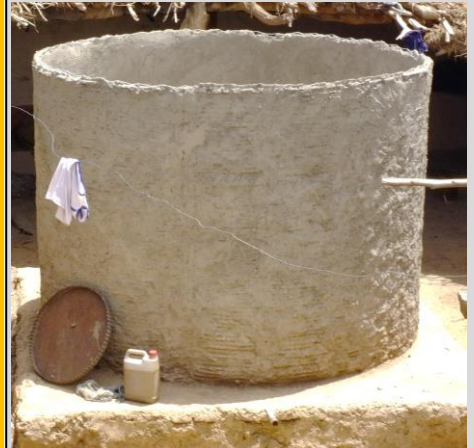

Picture 19: Cistern body with rough surface after first plastering



Picture 20: The 7-8 cm thin cistern body after final plastering

- l) Apply two layers of cement plaster to the outside of the cistern.
- m) Apply one layer of pure cement plaster to the inside of the cistern and cast a 10 cm concrete floor so that the vertical inlet pipe sticks out min. 5 cm. Cure for 21 days.

### Working steps

- a) Place the four pieces of cistern cover mold on horizontal support bars mounted on 1.6m long wooden stilts, level with the cistern body top (see Figure 10).
- b) Cut and place reinforcement bars (RB) with a square spacing of 20 x 20 cm.
- c) Tie RBs together with black wire.
- d) Place the inner manhole mold box (25).
- e) Prepare PVC inlet pipe (21-24):  
Cut a 30 cm-long piece (diameter: 11 cm) (21); cut four 10 cm deep slots (22), heat with flame (23) and split into 4 directions (24); tie with wire on top of reinforcement bars. (25).

## 9. Cistern cover construction

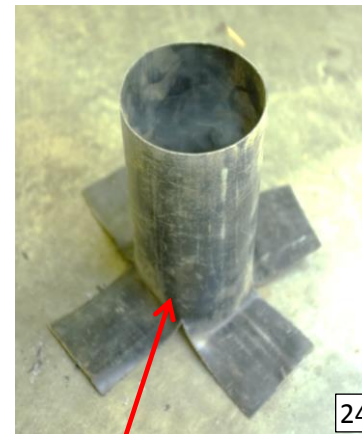

Pictures 21-24: Preparing the cistern cover inlet pipe

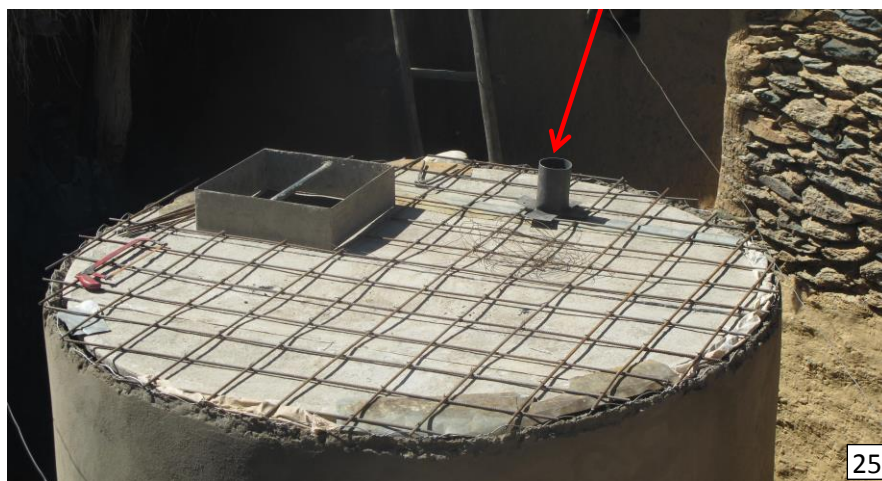

Pictures 25: Preparing the cistern cover inlet pipe





26

Picture 26: Placing the metal sheet collar and cover mold



27



30

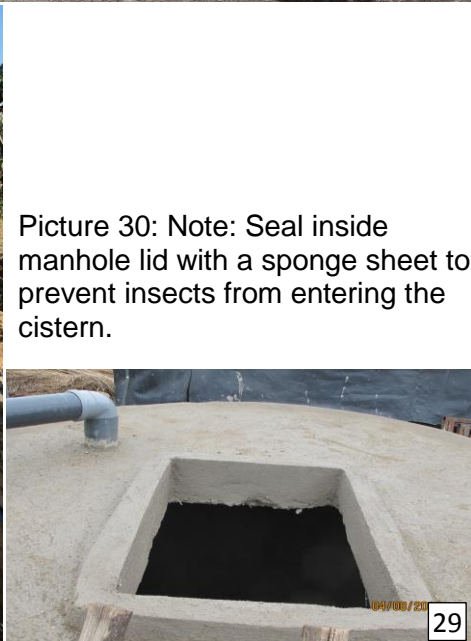

29

Picture 30: Note: Seal inside manhole lid with a sponge sheet to prevent insects from entering the cistern.

### Working steps (continued)

- f) Place the metal sheet “collar” (26) (0.8 mm thick, 33 cm wide, 7.5 m long) around the top of the cistern so that it extends a minimum of 6 cm above the cistern edge. Tie the collar firmly to the cistern with a rubber belt (27).
- g) Mix and cast concrete in a ratio of 1:2:3;  
1 bag (50 kg) cement;  
2 boxes (0.08 m<sup>3</sup>) sand;  
3 boxes (0.12 m<sup>3</sup>) gravel.  
Note: 1 box = 0.04 m<sup>3</sup>;  
Box dimension: 0.4 x 0.5 x 0.2 m
- h) Place outer rectangular manhole molds (28) and cast concrete with same ratio (27).
- i) Remove both manhole molds 30 minutes after casting (29).
- j) Remove cover mold 4 days after casting.
- k) Cure for a total of 21 days



28

Pictures 27-30: Cistern cover after concrete casting with metal sheet collar mold still in place (27). Placing the manhole molds (28). Manhole after removing molds (29). Manhole covered with lid (30).

## 10. Outlet pit construction

### *Working steps*

- a) Excavate a 60 x 60 x 70 cm pit and put some gravel on the pit floor.
- b) Make a 10 cm high cement rim around the pit boundary in order to prevent run off water from entering.
- c) Fix 1" water tap on outlet pipe



*Picture 31: Water outlet pit*

Note: Selecting a robust water tap is important as it is the most fragile and often mishandled part of the RWH system. The water tap shown in the picture (32) possesses a simple valve with a rubber washer which can easily be replaced once the tap starts leaking.



*Picture 32: Water tap with replaceable rubber washer*



33



34



35



36

Note: Connect the maximum roof catchment area that can be conveniently included in order to increase water storage.



37

## 11. Connecting the roof catchment

### Working steps

- a) Ensure that the roof is level or has a slight gradient towards the cistern. Make adjustments if required.
- b) Measure roof length and cut PVC pipe accordingly. Note: Include as much roof catchment area as possible (33).
- c) Heat a sickle in fire and cut open the PVC pipe along one side (34).
- d) Mount PVC pipe over the corrugated iron roof edge, and tie with rubber belts. Nail rubber belts on wooden roof frame below and above corrugated iron sheets (35).
- e) Close PVC gutter pipe at the far end with a PVC plug.
- f) Connect the other side of the PVC pipe with the required pipes and fittings properly to the cistern. Arrange all pipes at right angles only (36).
- g) Seal manhole cover inside with a sponge sheet to ensure that no insects can enter and close the manhole.
- h) Extremely heavy hail storms can damage PVC pipes (36). Cut 20 cm wide corrugated iron sheet strips to cover all horizontal pipe parts as hail protection on top of the PVC gutter and inlet pipe. Fix hail protection metal sheet strips and tie them with rubber belts (37).

Pictures 36&37: Hail damage; hail protection

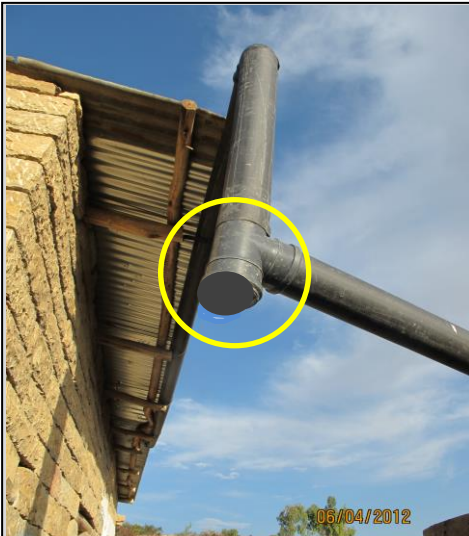

Picture 39: First splash discharge outlet

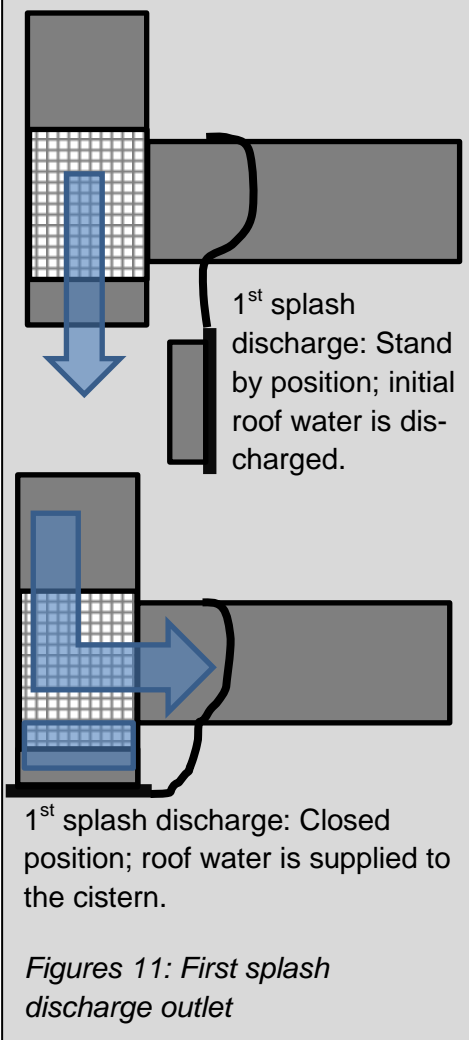

Figures 11: First splash discharge outlet

## 12. First splash discharge outlet

### Working steps

- Fit a standard T-shape PVC unit between vertical gutter pipe and horizontal cistern inlet pipe (Picture 39).
- Place a galvanized wire mesh (0.5 cm mesh size) inside the T-shape unit in order to prevent any waste and organic matter from being washed into the cistern. Keep reducer plug opened during rain-free periods. Attach the reducer plug with a rope to the horizontal inlet pipe as illustrated in Figure 11 (standby position). At the beginning of rainfall, allow roof water to be discharged for a short period until the roof is cleaned. Then close the reducer plug in order to collect the clean roof water in the cistern.

## 13. Operation and maintenance

### 13.1 Cleaning the cistern

- For cleaning the empty cistern, remove the water tap.
- The person in charge of cleaning the inside of the cistern has to maintain strict hygiene (washing hands and feet with soap) and enter the cistern without shoes.
- Remove the coupler of the outlet pipe at the cistern bottom with a pipe wrench. Then wash the entire internal part of the cistern with soapy water and a brush. Finally rinse the cistern and flush out all water through the outlet pipe. Fit the coupler and water tap properly.

### 13.2 Chlorination

- Measure the amount of water in the cistern by measuring from the bottom of the cistern up to current water level:  
Per cm measured, the amount of water is 42<sup>2</sup> Lt. e.g. a cistern filled with 125 cm of water holds 5'250 Lt.
- Take required amount of chlorine: use 1 gram of chlorine powder per 1'000 Lt of water. Hence, a completely filled cistern of 7'200 Lt would require approximately 7 grams of chlorine.
- Pour chlorine powder into a bucket filled with water and stir until the powder is dissolved.
- Pour the mixture of chlorine and water into the cistern. Take several buckets of water from the cistern and pour it back in order to stir and evenly distribute the chlorine solution in the cistern.
- Instruct users not to take any water from the cistern for 24 hours.
- Repeat chlorination after approximately six months. Even better is to use appropriate mobile water quality monitoring kits.

2: The exact measurement is 41.5 Lt per cm water measured

## Appendix

### I. Quality management

The below checklist provides quality standards for each RWHS component. It can be applied for systematic quality control. RWHS that fail to meet the required quality standard (Pass Mark) must be adjusted or replaced.

<b>Quality Checklist - Kalamino Cistern RWH System</b>	Max rating	Actual rating	Pass Mark
<b>1. Foundation</b>			
a) Dimensioning & foundation excavation 0.20 m, foundation above ground level	3		
b) Quality of masonry work stone alignment (spacing b/n stones)	3		
c) Vertical & horizontal alignment of the foundation & quality of plastering.	3		
d) Outlet pipe should be perfectly level, perpendicular to foundation.	3		
<b>Component total</b>	<b>12</b>		<b>9</b>
<b>2. Cistern (concrete and plastering work)</b>			
a) Centering of cistern on foundation.	3		
b) Concrete and plastering work should provide smooth surfaces (no bleeding & segregation).	3		
c) Concrete floor must be 10 cm thick	3		
c) Thickness of cistern body must be 7-8 cm	3		
d) Concrete lid should be level; smooth joints; lid opening cover can be lifted smoothly.	3		
e) Thickness of concrete lid must be 6-7 cm.	3		
f) Proper curing period of 21 days kept.	3		
<b>Component total</b>	<b>21</b>		<b>18</b>
<b>3. Roof catchment system</b>			
Proper slope of roof & inlet canal.	3		
Optimum of available roof area captured	3		
Fixing & aligning of PVC pipes & fittings (all pipes aligned in rectangles)	3		
Proper installation of 1 <sup>st</sup> splash discharge pipe (to be handled easily from the ground).	3		
<b>Component total</b>	<b>9</b>		<b>7</b>
<b>4. Outlet pit</b>			
a) Dimension (ability to place a standard jerrycan underneath the tap)	3		
b) Water tap fitting	3		
c) Drainage (gravel on floor, cement rim around pit)	3		
<b>Component total</b>	<b>9</b>		<b>7</b>
<b>5. Economic use of construction materials</b>			
Sand	3		
Gravel	3		
Cement	3		
Accessories	3		
<b>Component total</b>	<b>12</b>		<b>11</b>
<b>6. Orientation &amp; instruction of users</b>			
a) Cleaning of cistern before filling water.	3		
b) Predominant use as drinking water.	3		
c) Proper understanding and use of 1 <sup>st</sup> splash discharge and filling mechanism.	3		
d) Hygiene around water outlet.	3		
<b>Component total</b>	<b>12</b>		<b>10</b>
<b>Total</b>	<b>75</b>		<b>62</b>

Ratings: 0 = not applied; 1 = inadequately/incorrectly applied; 2 = partially applied; 3 = fully applied

## II. Common mistakes

No	Mistakes	Consequences
1	Roof gradient does not tilt towards the cistern	Overflow of gutter pipe; loss of roof water; need to correct roof gradient
2	Outlet pipe is not placed perfectly level into the foundation	Looks unprofessional; Cleaning water may not flush out properly when outlet is tilted upwards towards the water tap.
3	Improper mixing of sand and cement: Body work, Sand/Cement: 4/1 Final plastering, Sand/Cement: 3/1	Instability of structure; formation of cracks
4	Insufficient curing: Curing is a period of several days when cement needs to be kept moist with the help of wet Sisal bags or other textiles. After splashing the cistern body with water, plastic sheeting can also be used to reduce evaporation. Cement requires usually 21 days of curing. This requires three 20 Lt jerry cans of water per cistern per day. Labor requirement to supply water for curing in water-scarce areas must be considered carefully.	Cement cracking; leaking of cistern. Need to re-plaster cracked parts.
5	a) 1 <sup>st</sup> splash discharge outlet cannot conveniently be reached without using a ladder. b) 1 <sup>st</sup> splash discharge outlet is not operated correctly (kept closed all the time).	Unclean roof water is washed into the cistern when initial roof water is not discharged.
6	Wire mesh inside 1 <sup>st</sup> splash discharge outlet is missing	Organic materials or living creatures may enter the cistern
7	No placement of hail protection metal sheets of vertical PVC pipes	Pipe damage during exceptionally heavy hail storms. Need to replace damaged PVC pipes
8	Utilization of water for other purposes than drinking water	Cistern empties quickly
9	Failure to monitor water quality	Contaminated water may be consumed undetected
10	Failure to collect water fee from beneficiary households and keep trained Community Technicians after project implementation	The following services are not provided: a) water quality monitoring b) spare part supply c) RWHS maintenance and repairs
11	Failure to organize beneficiary households in WASHCOs	Improper water use; inappropriate operation of RWHS; unsustainable water supply

### III. Bill of quantity (BoQ) - Kalamino cistern roof water harvesting system

#### Construction materials

No	Item	Unit	Quantity	Unit Price ETB	Total Cost ETB	Total Cost USD
<b>1.</b>	<b>Cistern foundation</b>					
1.1	Cement (PPC)	Quintal <sup>1</sup>	1.5	230	345.00	
1.2	Sand	m <sup>3</sup>	0.45	406	182.70	
1.3	Gravel 02	m <sup>3</sup>	0.16	350	56.00	
1.4	Galvanized steel pipe B-class(ISP)1"	m	1.5	141	211.50	
1.5	Water tap 1"	No	1	150	150.00	
1.6	Coupler (GSP)1"	No	2	30	60.00	
1.7	Elbow (GSP) 1"	No	1	25	25.00	
1.8	Teflon tape	Roll	1	30	30.00	
	<b>Component total</b>				<b>1,060.20</b>	<b>51</b>
<b>2.</b>	<b>Cistern body</b>					
2.1	Cement (PPC)	Quintal <sup>1</sup>	4.25	230	977.50	
2.2	Sand	m <sup>3</sup>	1.25	406	507.50	
2.3	Gravel 02	m <sup>3</sup>	0.24	350	84.00	
2.4	Wire mesh 2.5 mm thick (Size: 7.5 m x 1.85 m)	m <sup>2</sup>	13.875	103.8	1,440.20	
2.5	Tie wire 2 mm thick	kg	0.8	30	24.00	
	<b>Component total</b>				<b>3,033.20</b>	<b>144</b>
<b>3.</b>	<b>Cistern cover (including manhole cover)</b>					
3.1	Cement (PPC)	Quintal <sup>1</sup>	0.75	230	172.5	
3.2	Sand	m <sup>3</sup>	0.3	406	121.8	
3.3	Gravel 02	m <sup>3</sup>	0.24	350	84.00	
3.4	Reinforcement bar Ø 8 mm (6 m long pieces)	Pcs	4	130	520.00	
3.5	Reinforcement bar Ø 6 mm	kg	1	30	30.00	
3.6	Cement for finish plastering (all cistern parts)	Quintal <sup>1</sup>	0.5	230	115.00	
3.7	2 mm thick metal sheet for manhole cover	m <sup>2</sup>	0.45	755.55	340.00	
	<b>Component total</b>				<b>1,383.30</b>	<b>66</b>
<b>4.</b>	<b>Materials for roof catchment connection</b>					
4.1	PVC pipe (Ø 110 mm, thickness 1.5 mm)	Pcs	2.5	200	500.00	
4.2	PVC elbow	Pcs	2	35	70.00	
4.3	PVC T	Pcs	1	45	45.00	
4.4	PVC plug	Pcs	1	55	55.00	
4.5	PVC reducer	Pcs	1	25	25.00	
4.6	PVC glue	kg	0.25	185	46.25	
4.7	20 cm wide sheet metal strips for hail protection	m	8	35	280.00	
4.8	Rubber belt (made from old car tires)	m	3	8.35	25.05	
4.9	Roof nails	kg	0.25	55	13.75	
	<b>Component total</b>				<b>1,060.05</b>	<b>51</b>
<b>5.</b>	<b>Labor</b>					
5.1	Skilled labor (before income tax)	LS			1,730.00	
	<b>Component total</b>				<b>1,730.00</b>	<b>82</b>
	<b>GRAND TOTAL (excluding transport cost)</b>				<b>8,266.75</b>	<b>394</b>
	Total amount of cement per cistern	Quintal <sup>1</sup>	7			
	Total amount of sand per cistern	m <sup>3</sup>	2.0			
	Total amount of gravel 02 per cistern	m <sup>3</sup>	0.64			
	1) Quintal = 100 kg					

**IV. Bill of quantity (BoQ) - Kalamino cistern roof water harvesting system**  
**Construction materials cistern molds**

No	Item	Unit	Quantity	Unit Price ETB	Total Cost ETB	Total Cost USD
<b>1</b>	<b>Cistern body mold</b>					
	Rectangular hollow steel size 25 x 25 x 2 mm thick (RHS)	m	37	50	1,850.00	
	U-channel steel 40 mm x 20 mm	m	37	135	4,995.00	
	Flat bar 40 mm 3 mm thick	m	37	42	1,554.00	
	PVC pipe Ø 25 mm 10 bar pressure resistant	m	500	14	7,000.00	
	Wooden purlin size 5 mm x 4 mm (spacer between two molds)	m	8	25	200.00	
	Reinforcement bar Ø10 mm thick for mold handle	m	5.6	25	140.00	
	<b>Component-total</b>				<b>15,739.00</b>	<b>750</b>
<b>2</b>	<b>Cistern cover mold</b>					
	Rectangular hollow steel size 25 x 25 x 2 mm thick (RHS)	m	20	50	1,000.00	
	Rectangular hollow steel for support size 70 x 70 x 2 mm thick (RHS)	m	4	200	800.00	
	Sheet metal size 2m x 1m x 1.25 mm thick	Pcs	3	550	1,650.00	
	Four wooden stilts (each 1.6 m long)	Pcs	4	20	80.00	
	Sheet metal "collar" (0.8 mm thick, 33 cm wide, 7.5 m long)	m	7.5	125	938.00	
	Rubber belt	m	26	9	117.00	
	<b>Component-total</b>				<b>4,585.00</b>	<b>218</b>
<b>3</b>	<b>Cistern manhole mold</b>					
	Sheet metal 2 mm thick size 45 cm x 45 cm	Ls	1	400	400.00	
	Iron steel pipe 3/4"	m	0.45	65	29.25	
	Angle bar 40 mm x 2.5 mm thick (size 55 cm x 55cm)	Ls	1	600	600.00	
	<b>Component-total</b>				<b>1,029.25</b>	<b>49</b>
	<b>TOTAL</b>				<b>21,353.25</b>	<b>1,017</b>